



U.S. Department
of Transportation
Federal Aviation
Administration

Advisory Circular

Subject: Non-Towered Airport Flight
Operations

Date: 6/6/23

AC No: 90-66C

Initiated by: AFS-800

Change:

- 1 PURPOSE OF THIS ADVISORY CIRCULAR (AC).** This AC calls attention to regulatory requirements, recommended operations, and communications procedures for operating at an airport without a control tower or an airport with a control tower that operates only part time. It recommends traffic patterns, communications phraseology, and operational procedures for use by aircraft, lighter-than-air aircraft, gliders, parachutes, rotorcraft, and ultralight vehicles. This AC stresses safety as the primary objective in these operations. This AC is related to Title 14 of the Code of Federal Regulations (14 CFR) part [1](#), § [1.1](#) (traffic pattern), and part [91](#), § [91.13](#) (Careless or Reckless Operation), § [91.113](#) (Right-of-Way Rules: Except Water Operations), and § [91.126](#) (Operating On or In the Vicinity of an Airport in Class G Airspace). The contents of this document do not have the force and effect of law and are not meant to bind the public in any way, and the document is intended only to provide information to the public regarding existing requirements under the law or agency policies.
- 2 AUDIENCE.** This AC applies to aircraft operators operating at or in the vicinity of an airport without a control tower or an airport with a control tower that operates only part time.
- 3 WHERE YOU CAN FIND THIS AC.** You can find this AC on the Federal Aviation Administration's (FAA) website at https://www.faa.gov/regulations_policies/advisory_circulars and the Dynamic Regulatory System (DRS) at <https://drs.faa.gov>.
- 4 WHAT THIS AC CANCELS.** AC 90-66B CHG 1, Non-Towered Airport Flight Operations, dated February 25, 2019, is canceled.
- 5 PRINCIPAL CHANGES.** This AC has been updated to reflect current procedures and best practices at airports without an operating control tower or an airport with a control tower that operates only part time.
- 6 DEFINITIONS.**
 - 6.1 Back-Taxi.** A term used by air traffic controllers to taxi an aircraft on the runway opposite to the traffic flow. The aircraft may be instructed to back-taxi to the beginning of the runway or at some point before reaching the runway end for the purpose of departure or to exit the runway.
 - 6.2 Chart Supplements/Terminal Procedures.** A Chart Supplement is a publication designed primarily as a pilot's operational manual containing all airports, seaplane bases,

and heliports open to the public, including communications data, navigational facilities, and certain special notices and procedures. This publication is issued in seven volumes according to geographical area and the airports' information. See Airport Chart Supplements in paragraph 7 below. Terminal procedures address available instrument approaches at an airport.

6.3 Common Traffic Advisory Frequency (CTAF). A frequency designed for the purpose of carrying out airport advisory practices while operating to or from an airport without an operating control tower. The CTAF may be a Universal Communications (UNICOM), MULTICOM, Flight Service Station (FSS), or tower frequency, and is identified in appropriate aeronautical publications.

6.3.1 Universal Communications (UNICOM) Frequency. These systems offer a variety of features, typically selectable by microphone clicks, on the UNICOM frequency. Availability will be published in the Chart Supplement U.S. and approach charts.

6.3.2 MULTICOM. A mobile service, not open to public correspondence use, used for essential communications in the conduct of activities performed by or directed from private aircraft.

6.4 Hotline Complaint. If the pilot experiences a threat to their safety during any flight operation, they have the right to file an FAA Hotline complaint. The FAA Hotline accepts reports related to the safety of the National Airspace System (NAS), violation of 14 CFR, aviation safety issues, and reports related to FAA employees or FAA facilities. The FAA Hotline provides a single venue for FAA employees, the aviation community, and the public to file their reports.

6.5 Movement Area. The runways, taxiways, and other areas of an airport/heliport that are used for taxiing/hover taxiing, air taxiing, takeoff and landing of aircraft, exclusive of loading ramps, and parking areas.

6.6 Non-Towered Airports. Airports without control towers or airports with control towers that are not operating. These airports are commonly referred to as non-towered or part-time-towered airports. Another term commonly used is "uncontrolled airport."

6.7 Traffic Pattern. The traffic flow that is prescribed for aircraft landing at, taxiing on, or taking off from an airport.

7 RELATED READING MATERIAL.

1. [Aeronautical Information Manual](#) (AIM).
2. [Airplane Flying Handbook](#).
3. [Airport Chart Supplements](#).
4. Aircraft Owners and Pilots Association (AOPA) at <https://www.aopa.org/>.
5. [FAA Aeronautical Chart Users' Guide](#).

6. FAA Hotline at https://www.faa.gov/about/office_org/headquarters_offices/aae/programs_services/faq_hotlines.
7. [Fly Neighborly Guide](#), Helicopter Association International.
8. Notices to Air Missions (NOTAM) at https://www.faa.gov/air_traffic/publications/notices/.
9. Operations at Non-Towered Airports, AOPA, Air Safety Institute pamphlet.
10. [Pilot/Controller Glossary](#).
11. [Pilot's Handbook of Aeronautical Knowledge](#) (PHAK) (FAA-H-8083-25B).
12. State Aviation Publications.
13. Terminal Procedures at https://www.faa.gov/air_traffic/flight_info/aeronav/digital_products/dtpp/search/.
14. United States Parachute Association at <https://uspa.org/>.
15. United States Ultralight Association at <https://www.usua.org>.
16. Various Pilot Guides.

7.1 ACs. The current editions of the following ACs also contain information applicable to operations at airports without operating control towers.

1. AC [90-23](#), Aircraft Wake Turbulence.
2. AC [90-48](#), Pilots' Role in Collision Avoidance.
3. AC [91-32](#), Safety In and Around Helicopters.
4. AC [103-6](#), Ultralight Vehicle Operations—Airports, Air Traffic Control, and Weather.
5. AC [105-2](#), Sport Parachuting.
6. AC [107-2](#), Small Unmanned Aircraft Systems (Small UAS).

8 BACKGROUND AND SCOPE.

8.1 In the interest of promoting safety, the FAA, through its AIM, Chart Supplements, ACs, and other publications, provides radio frequency information, good operating practices, and procedures for pilots to use when operating at an airport without an operating control tower. The FAA believes that observance of a standard traffic pattern and the use of CTAF procedures, as detailed in this AC, will improve the safety and efficiency of aeronautical operations at airports without operating control towers.

8.2 Regulatory provisions relating to traffic patterns are found in 14 CFR parts 91, [93](#), and [97](#). The airport traffic patterns described in part 93 relate primarily to those airports where there is a need for unique traffic pattern procedures not provided for in part 91. Part 97 addresses instrument approach procedures (IAP). At airports without operating control towers, part 91 requires only that pilots of airplanes approaching to land make all turns to the left, unless the airport's Chart Supplement or the airport's segmented circle

indicates a different traffic pattern flow. Refer to the PHAK, Chapter 14, Airport Operations, and the AIM, Chapter 4, Section 3, Airport Operations).

8.2.1 The FAA does not regulate traffic pattern entry, only traffic pattern flow. This means that when entering the traffic pattern at an airport without an operating control tower, inbound pilots are expected to observe other aircraft already in the pattern and to conform to the traffic pattern in use. If there are no other aircraft present, the pilot should check traffic indicators on the ground and wind indicators to determine which runway and traffic pattern direction to use. For example, an aircraft on an instrument approach flying on the final approach course to land would follow the requirements dictated by the approach procedure. Further, to mitigate the risk of a midair collision at a non-towered airport in other than instrument conditions, the FAA does not recommend that the pilot execute a straight-in approach for landing, when there are other aircraft in the traffic pattern. The straight-in approach may cause a conflict with aircraft in the traffic pattern and on base to final and increase the risk of a midair collision.

8.2.1.1 Traffic pattern entry and turn direction information is provided by using the airport remarks or Chart Supplement, or by referring to the AIM and the PHAK or this AC. An aircraft in the traffic pattern of an airport is considered an aircraft approaching to land at the airport. At an airport without a control tower, the pilot must fly the traffic pattern with left turns, unless otherwise stated in the Airport Chart Supplement, or as stated on the visual flight rules (VFR) Chart symbol for the respective airport. (Refer to § 91.126(b), the note below, and example.) That is, unless otherwise stated, all traffic pattern turns are to the left unless the airport designates that traffic pattern turns be made to the right.

Note: An aircraft outside the traffic pattern would not be bound by § 91.126(b) (see paragraph [11.3](#) and Appendix [A](#), Traffic Patterns, for aircraft crossing over midfield above pattern altitude to enter the pattern). Unless otherwise required by part 93, or authorized or required by ATC, the requirements for traffic pattern flow under § 91.126 continue to apply to other airspace classification types under § [91.127](#) (Class E airspace), § [91.129](#) (Class D airspace), and § [91.130](#) (Class C airspace). This is particularly likely when a towered airport is operating as a non-towered airport.

Note: From the VFR Sectional Chart, a non-towered airport will indicate a right-traffic pattern with “RP” in the airport information on the sectional, which indicates that a right-traffic pattern is used at this airport. Runways requiring the use of the right pattern are listed after the RP. An example would be RP 32, meaning that a right pattern is in use on Runway 32 (see Figure [1](#), Sample VFR Sectional Chart With RP 32, below). If an RP is not noted, it is assumed that the traffic pattern is a left pattern.

Figure 1. Sample VFR Sectional Chart With RP 32



9 GENERAL OPERATING PRACTICES.

- 9.1 Preflight Actions.** As part of the § [91.103](#) preflight requirements that a pilot become familiar with all available information concerning a flight, each pilot should review all appropriate publications (e.g., Chart Supplements, the AIM, and NOTAMs) for pertinent information on current traffic patterns at the departure and arrival airports. The Chart Supplement U.S. contains information such as special notices, FAA and National Weather Service (NWS) telephone numbers, preferred instrument flight rules (IFR) routing, VFR waypoints, a listing omni-directional range receiver checkpoints, aeronautical chart bulletins, land-and-hold-short operations (LAHSO), airport diagrams, en route flight advisory service (EFAS) outlets, parachute jumping areas, the airport's facility telephone numbers, and at non-towered airports, how to operate the pilot-controlled runway lights. It is beneficial to review a Chart Supplement U.S. to become familiar with this information.
- 9.2 Fly the Standard Traffic Pattern.** Arriving aircraft should enter the airport's traffic pattern at traffic pattern altitude and avoid straight-in approaches for landing to mitigate the risk of a midair collision. See the paragraphs below and paragraph [11](#) for additional information.
- 9.3 Information Provided by UNICOM.** UNICOM stations may, upon request, provide pilots with weather information, wind direction, the recommended runway, or other necessary information. If the UNICOM frequency is designated as the CTAF, it will be identified in appropriate aeronautical publications. If wind and weather information is not available, it may be obtainable from nearby airports via the Automatic Terminal Information Service (ATIS) or Automated Weather Observing System (AWOS). UNICOM operators are not required to communicate with pilots, and if they do, there are no standards for the information conveyed.

9.4 Airport Runway Lighting. Refer to the airport's Chart Supplement to determine whether the runway lighting is controlled by the airport's CTAF frequency. This can be a significant aid to identify your destination airport, as well as the runway in use.

9.5 Prior to Takeoff, VFR or IFR, Traffic Verification, and Communications.

Communication at non-towered airports or at airports where the control tower is closed is critical. Pilots are reminded that in these cases surveillance of other traffic by the air traffic controller is removed from the safety picture; hence, you are assuming this role. All traffic, whether IFR or VFR, should, at a minimum, monitor the CTAF. For departures a minimum of 10 minutes prior to taxi and arrivals a minimum of 10 miles out from the airport, you should broadcast your intentions. The importance of air-to-air communications cannot be overemphasized. Failure to follow this communication protocol has contributed to near midair collisions (NMAC), and as such could be considered careless and reckless operation of an aircraft.

Note: If ATC issues a "departure release," this is not an authorization to takeoff. The pilot should communicate over the airport's CTAF their call sign, the runway they will use to takeoff, their departure direction, and initial climb altitude; coordinate their takeoff with other aircraft inbound and with aircraft in the traffic pattern before taking off to mitigate the risk of a surface or a midair collision. If the departing aircraft has a clearance void time, and cannot safely takeoff, then they should contact ATC and advise that they need to obtain another clearance void time.

9.5.1 VFR. The pilot should not enter the runway in use for takeoff unless they verify that there is no landing traffic either opposite to their runway for takeoff or aligned with their runway for takeoff. The pilot should also ensure that, by entering the runway, they do not cause a traffic conflict with operations on any other runway.

9.5.2 IFR. The pilot should consider the same factors as when flying VFR described in paragraph 9.5.1. However, remember that the air traffic control (ATC) IFR release is not authorization for takeoff.

Note: Crews/pilot should monitor the CTAF for any inbound traffic and coordinate their departure.

9.5.3 Pre-Takeoff Communications. On the airport's CTAF, you should communicate and coordinate your takeoff intention with aircraft inbound and in the traffic pattern and announce the runway to be used, the direction of flight on departure, or whether you intend to remain in the traffic pattern. This action will reduce the risk of a surface or midair collision during takeoff. Also, coordinate the takeoff with other traffic in the traffic pattern, traffic inbound for landing, or traffic on a straight-in approach to any of the airport's runways.

9.6 MULTICOM Frequencies. Where there is no tower, CTAF, or UNICOM station depicted for an airport on an aeronautical chart, use MULTICOM frequency 122.9 for

self-announce procedures. Such airports should be identified in appropriate aeronautical information publications.

- 9.7 Be Alert for Other Than a Left-Hand Traffic Pattern.** If the Chart Supplement lists a right-hand traffic pattern at a non-towered airport, pilots conducting practice instrument approaches in visual meteorological conditions (VMC) should circle to the right to enter the traffic pattern.
- 9.8 Self-Announce Position and/or Intentions.** “Self-announce” is a procedure whereby pilots broadcast their aircraft call sign, position, altitude, and intended flight activity or ground operation on the designated CTAF. This procedure is used almost exclusively at airports that do not have an operative control tower or an FSS on the airport. If an airport has a control tower that is either temporarily closed or operated on a part-time basis, and there is no operating FSS on the airport, pilots should use the published CTAF to self-announce position and/or intentions when entering within 10 miles of the airport.
- 9.8.1 Self-Announcing.** Self-announcing should include aircraft type to aid in identification and detection, but should not use paint schemes or color descriptions to replace the use of the aircraft call sign. For example, “MIDWEST TRAFFIC, TWIN COMMANDER FIVE ONE ROMEO FOXTROT TEN MILES NORTHEAST” or “MIDWEST TRAFFIC, FIVE ONE ROMEO FOXTROT TWIN COMMANDER TEN MILES NORTHEAST.” When referring to a specific runway, pilots should use the runway number and not use the phrase “Active Runway.” To help identify one airport from another when sharing the same frequency, the airport name should be spoken at the beginning and end of each self-announce transmission.
- Note:** Refer to AIM, Chapter 4, Section 1. Pilots are reminded that the use of the phrase “ANY TRAFFIC IN THE AREA, PLEASE ADVISE” is not a recognized self-announce position and/or intention phrase and should not be used under any condition. Any traffic that is present at the time of your self-announcement that is capable of radio communications should reply without being prompted to do so.
- 9.9 Left Traffic.** Use of standard traffic patterns (left turns) for all aircraft and CTAF procedures by radio-equipped aircraft are required at all airports without operating control towers unless indicated otherwise by visual markings, light gun signals, airport publications, or published approach procedure. A pilot should understand that other traffic patterns (right turns) may already be in common use at some airports or that special circumstances or conditions exist that may prevent use of the standard traffic pattern. Right-hand patterns are noted at airports on an aeronautical chart with an “RP” designator and the applicable runway next to the airport symbol. See paragraph [11](#) for detailed information.
- 9.10 Collision Avoidance.** The pilot in command’s (PIC) primary responsibility is to see and avoid other aircraft and to help other aircraft see and avoid his or her aircraft. You should keep lights and strobes on. The use of any traffic pattern procedure does not alter the responsibility of each pilot to see and avoid other aircraft. Pilots are encouraged to participate in “Operation Lights On,” a voluntary pilot safety program described in the

AIM (paragraph 4-3-23) that is designed to improve the “see-and-avoid” capabilities. Refer to AC 90-48 for additional information.

- 9.10.1 Unmanned Aircraft (UA).** UA, commonly known as drones, and their associated operating systems can operate as recreational, commercial, or public aircraft. Recreational, commercial, and public drones generally do not require authorization to operate in Class G airspace, nor are UA required to maintain radio communications with other aircraft. The remote PIC must always yield right-of-way to a manned aircraft and not interfere with manned aircraft operations. The FAA encourages remote PICs to use caution when operating in and around the vicinity of airports because their aircraft may be difficult to see or be recognized by pilots of manned aircraft. Additional information regarding unmanned aircraft operations may be found in AC 107-2 and 14 CFR part [107](#).

Note: According to part 107, § [107.41](#), operators of small UA are required to obtain ATC authorization prior to operating in Class B, C, D, and surface Class E airspaces.

- 9.11 Traffic Flow.** The FAA recommends that pilots use visual indicators, such as the segmented circle, wind direction indicator, landing direction indicator, and traffic pattern indicators that provide traffic pattern information. If other traffic is present in the pattern, arriving or departing aircraft should use the same runway as these aircraft. Transient aircraft may not know local ground references, so pilots should use standard pattern phraseology, including distances from the airport.
- 9.11.1 Straight-In Landings.** The FAA discourages VFR straight-in approaches to landings due to increased risk of a midair collision. However, if a pilot chooses to execute a straight-in approach for landing without entering the airport traffic pattern, the pilot should self-announce their position on the designated CTAF between 8 and approximately 10 miles from the airport, and coordinate their straight-in approach and landing with other airport traffic. Pilots choosing to execute a straight-in approach do not have a particular priority over other aircraft in the traffic pattern and must comply with the provisions of § 91.113(g).

Note: Section 91.113(b) requires all pilots to see and avoid. Refer to AC 90-48 for further guidance on reducing the risk of a midair collision.

- 9.11.2 Aircraft Operating in the Traffic Pattern at a Non-Towered Airport.** All traffic within a 10-mile radius of a non-towered airport, or a part-time-towered airport when the control tower is not operating, should monitor and communicate on the designated CTAF when entering the traffic pattern. Pilots must remain vigilant to comply with the requirement to see and avoid other aircraft (refer to § 91.113), which could include aircraft conducting straight-in approaches to land, and should communicate their position in the pattern with other aircraft in the traffic pattern to avoid a possible traffic conflict. In the airport traffic pattern, good communication and a pilot’s responsibility to see and avoid are essential mitigations to avoid a possible midair collision. In addition, following established traffic pattern procedures eliminates excessive maneuvering at low altitudes, reducing the risk of loss of aircraft control. The following is an example of traffic pattern position reporting:

state, “Entering left/right downwind for runway [XX];” when on the downwind, state, “On the left/right downwind for runway [XX];” when on base leg, state, “On left/right base for runway [XX];” finally, when turning, state, “On final for runway [XX].”

Note: Most importantly, all pilots operating at a non-towered airport have the responsibility to see and avoid under § 91.113(b). Refer to AC 90-48 for further guidance on reducing the risk of a midair collision.

- 9.11.3** IFR Traffic. Pilots conducting instrument approaches in VMC should be particularly alert for other aircraft in the pattern so as to avoid interrupting the flow of traffic and should bear in mind they do not have priority over other VFR traffic. Pilots are reminded that circling approaches must comply with § 91.126(b) unless the approach procedure explicitly states otherwise. Remember, if the Chart Supplement lists right-hand traffic at a non-towered airport, pilots conducting practice instrument approaches in VMC should circle to the right to enter the traffic pattern.
- 9.11.4** Practice Instrument Approaches at Non-Towered Airports versus VFR Aircraft in the Traffic Pattern. Pilots conducting instrument approaches at non-towered airports should be alert for other aircraft in the pattern, and should follow these best practices:
- 9.11.4.1** **Announce and Coordinate for Safety.** Announce their distance from the runway aligned with the instrument approach being flown, and their intention to land, conduct a touch-and-go, fly the published missed approach, or at the missed approach point break off the instrument approach.
- 9.11.4.2** **Communicate to Avoid the Risk of a Midair Collision.** To avoid the risk of a midair collision, communicate with the pilots already in the traffic pattern and advise them of your intentions, and determine the safety of flying the published missed approach, or conducting a touch and go or a full stop landing. Per coordination with the other aircraft already in the traffic pattern, safety may be best served by breaking off the approach and entering the airport’s downwind leg to not disturb the current flow of landing and departing aircraft.
- 9.11.4.3** **If Not Planning to Fly the Published Missed Approach, Communicate.** If not planning to fly the published missed approach, communicate your over CTAF your intentions to aircraft on the airport’s CTAF. For example, “Cessna N1234 on VOR 6 not flying the published missed approach, turning [state direction] for another approach [state, leaving the area].” This will reduce the risk of a midair collision with aircraft in the traffic pattern and inbound to the airport for landing.
- 9.11.5** Consider That Non-Instrument-Rated Pilots May Not Understand. A non-instrument-rated pilot might not understand radio calls referring to approach waypoints, depicted headings, or missed approach procedures. IFR pilots often indicate that they are on a particular approach, but that may not be enough information for a non-IFR-rated pilot to know your location. It is better to provide specific direction and

distance from the airport, as well as the pilot's intentions upon completion of the approach. For example, instead of saying, "PROCEDURE TURN INBOUND V-O-R APPROACH 36," state, "6 MILES SOUTH INBOUND V-O-R APPROACH RUNWAY 36, PLANNING TURNING (right or left) TO AVOID FLYING OVER THE AIRPORT, or state, "6 MILES SOUTH INBOUND V-O-R APPROACH RUNWAY 36, LANDING FULL STOP." You should be clear and concise. The other traffic needs to know what to expect in order to take appropriate actions that avoid a midair collision.

9.12 Other Considerations at Non-Towered Airports.

9.12.1 Flight Inspection Aircraft. Pilots should be aware that flight inspection aircraft may be operating near the airport, in a nonstandard traffic pattern or opposite direction to conduct inspection of navigational aids. In addition, flight inspection aircraft frequently conduct low approaches over the runway. Flight inspection aircraft use the call sign "flight check" and will self-announce their position and intentions on the designated frequency. Pilots should be vigilant when they hear "flight check" on the frequency.

9.12.2 No-Radio Aircraft. Pilots should be aware that procedures at airports without operating control towers generally do not require the use of two-way radios; therefore, pilots should be especially vigilant for other aircraft while operating in the traffic pattern. Pilots of inbound aircraft that are not capable of radio communications should determine the runway in use prior to entering the traffic pattern by observing the landing direction indicator, the wind indicator, landing and departing traffic, previously referring to relevant airport publications, or by other means.

9.12.3 Turbulence Generated by Aircraft.

9.12.3.1 Wake Turbulence. A phenomenon that occurs when an aircraft develops lift and forms a pair of counter-rotating vortices. All aircraft generate wake turbulence. Therefore, pilots should be prepared to encounter turbulence while operating in a traffic pattern and especially when in the trail of other aircraft. Wake turbulence can damage aircraft components and equipment. In flight, and especially when in a traffic pattern, avoid the area below and behind the aircraft generating turbulence, especially at a low altitude where even a momentary wake encounter could be hazardous.

Note: All operators should be aware of the potential of wake turbulence when operating at any airport. Since the turbulence from a "dirty," flaps and landing gear extended, aircraft configuration hastens wake decay, the greatest vortex strength occurs when the generating aircraft is "HEAVY," "CLEAN," and "SLOW." Be alert to the wake turbulence you could be generating to smaller aircraft.

9.12.3.2 Rotor Wash. A phenomenon resulting from the vertical down wash of air generated by the main rotor(s) of a helicopter.

9.12.3.3 Propeller (Prop) Wash (Prop Blast). A disturbed mass of air generated by the motion of a propeller.

- 9.12.3.4 Jet Blast.** Force of the “air” from the rear section of the jet engine. Almost half of the jet blast incidents reported to the Aviation Safety Reporting System (ASRS) occurred on taxiways, in run-up areas, and adjacent to or on runways, all relatively uncongested airport areas. The other half occurred on ramps, where many more such incidents might be expected because of close aircraft parking and tight maneuvering conditions. You should give yourself ample distance behind a jet. For example, in one case, a small aircraft performing a run-up 150 feet behind and to the side of an airliner holding short of the runway experienced a wing and prop strike when the larger aircraft powered up. Refer to the FAA ASRS Ground Jet Blast Hazard.
- 9.12.4 Right-of-Way.** Throughout the traffic pattern, right-of-way rules apply as stated in § 91.113: “When weather conditions permit, regardless of whether an operation is conducted under instrument flight rules or visual flight rules, vigilance shall be maintained by each person operating an aircraft so as to see and avoid other aircraft. When a rule of this section gives another aircraft the right-of-way, the pilot shall give way to that aircraft and may not pass over, under, or ahead of it unless well clear.”
- 9.12.5 Other Approaches to Land and Airports with Multiple Runways.** Pilots should be aware of the other types of approaches to land that may be used at an airport when a pilot indicates they are doing so, which may or may not be initiated from the traffic pattern. The more common types of these include a short approach, low approach, or an overhead approach. Also, at airports with multiple runways, to reduce the risk of a collision on takeoff or arrival, you should be vigilant and scan for operations on other runways that may conflict with your operation. Some airports do not provide a clear line of sight to other runways, diminishing a pilot’s situational awareness during departures. You should be alert and aware of tower/aircraft communications, and identify what runway or runways are being used for takeoff and landing. If operating at a towered airport with crossing runways, and you are in doubt if the other aircraft’s takeoff runway will conflict with your takeoff, you should contact the tower to confirm if your takeoff runway will not conflict with another aircraft taking off. If at a non-towered airport, you should use the CTAF and ask the other departing aircraft which runway they are departing from or landing on to avoid the risk of a takeoff or landing collision with another aircraft.
- 9.12.5.1 A Short Approach.** A short approach is executed when the pilot makes an abbreviated downwind, base, and final legs turning inside of the standard 90-degree base turn. This can be requested at a towered airport for aircraft spacing, but is more commonly used at a non-towered airport or a part-time-towered airport when the control tower is not operating, when landing with a simulated engine out or completing a power-off 180-degree accuracy approach commercial-rating maneuver.
- 9.12.5.2 A Low Approach.** A low approach is executed when an aircraft intends to overfly the runway, maintaining runway heading but not landing. Aircraft flying practice instrument approaches commonly use this.

9.12.5.3 An Overhead Approach. An overhead approach is normally performed by aerobatic or high-performance aircraft and involves a quick 180-degree turn and descent at the approach end of the runway before turning to land (described in the AIM, Paragraph 5-4-27, Overhead Approach Maneuver).

9.13 Pilot Responsibility to See and Avoid and Pilot Avoiding Careless and Reckless Operations (§ 91.13). In the airport traffic pattern, effective communication and a pilot's responsibility to see and avoid are essential mitigations to avoid a possible midair collision. In addition, following established traffic pattern procedures eliminates excessive maneuvering at low altitudes which mitigate the risk of a loss-of-aircraft control. All aircraft in the pattern or those flying a straight-in approach for landing in order to mitigate the risk of a conflict should effectively communicate their type of aircraft, distance from the runway in use, and state that they will or will not land on the runway in use. It is important to remember that non-adherence to established procedures and operations in the airport traffic pattern or on the surface of the airport that could endanger the life or property of another and could expose the pilot to an investigation based upon their careless or reckless operation.

10 COMMUNICATIONS PROCEDURES. The following information is intended to supplement the AIM, Paragraph 4-1-9, Traffic Advisory Practices at Airports Without Operating Control Towers.

10.1 Recommended Communication Practices. To achieve the greatest degree of safety, it is essential that all radio-equipped aircraft transmit/receive on a common frequency identified for the purpose of airport advisories, as identified in appropriate aeronautical publications.

1. Pilots should only use the correct airport name, as identified in appropriate aeronautical publications, when self-announcing or exchanging traffic information to reduce the risk of confusion. For example, when landing at Midwest National Airport (KGPH), state, "Midwest National Traffic" as stated on the VFR aeronautical chart and as found in the Airport's Supplemental Chart information. Do not use the town's name "Mosby Traffic" or "Clay County Traffic."
2. To help identify one airport from another, the correct airport name should be spoken at the beginning and end of each self-announce transmission.
3. Pilots should clarify the intentions of another pilot if they do not fully understand the other pilot's intentions.
4. Pilots should limit communications on CTAFs to safety-essential information regarding arrivals, departures, traffic flow, takeoffs, and landings. The CTAF should not be used for personal conversations.
5. Pilots operating in the traffic pattern or on a straight-in approach must be alert at all times to other aircraft in the pattern, or conducting straight-in approaches, and should communicate their position to avoid a possible traffic conflict. In the airport traffic pattern and while on straight-in approaches to a runway, good communication and a pilot's responsibility to see-and-avoid are essential mitigations to avoid a possible

midair collision. In addition, following established traffic pattern procedures eliminates excessive maneuvering at low altitudes, reducing the risk of loss of aircraft control.

Note: Pilots should not broadcast their assumed sequence for landing when transmitting their position in the pattern. For example, “N1234 downwind, number 3 for landing.” This is the responsibility of ATC at towered airports.

- 10.2 Unnecessary Communications.** Avoid unnecessary CTAF communications. Keep in mind that while you are communicating, you may block transmissions from other aircraft that may be departing or landing in the opposite direction to your aircraft due to IFR operations, noise abatement, obstacle avoidance, or runway length requirements. An aircraft might be using a runway different from the runway in use.
- 10.3 Avoid Confusing Language.** Avoid confusing language that could attribute to the risk of a midair collision. To avoid misunderstandings, pilots should avoid using the words “to” and “for” whenever possible. These words might be confused with runway numbers or altitudes. Be specific and clear so that other pilots in the pattern are not confused as to the runway or procedure you intend to use to ensure you and the other pilots are clear as to each other’s positions within the traffic pattern to mitigate the possibility of a midair collision.
- 10.4 Recommended Traffic Advisory Practices.**
- 10.4.1 Arriving Aircraft.** Approximately 10 miles from the destination airport, monitor the CTAF for other traffic and self-announce your position, altitude, and intention. Also, all traffic within a 10-mile radius of a non-towered airport or a part-time-towered airport when the control tower is not operating should monitor and communicate their intentions on the designated CTAF as they approach to enter the traffic pattern to avoid a traffic conflict. For IFR-arriving aircraft, in addition to communicating with ATC, the pilot/crew is advised to monitor the airport’s CTAF to obtain traffic volume.
- 10.4.2 Departing Aircraft.** Unless otherwise stated in the Airport Chart Supplement for the airport reference to departure procedures, departing aircraft should monitor/communicate on the appropriate CTAF from startup, during taxi, and after departure, so to be aware of any inbound aircraft that could present a traffic conflict.
- Note:** At non-towered airports, the FAA discourages back-taxi operations because they increase the risk of a surface collision with landing aircraft. Remember, at towered airports, ATC authorizes a back-taxi and provides collision avoidance for this operation.
- 10.4.3 IFR Departure.** Unless otherwise stated in the Airport Chart Supplement for the airport reference to IFR departure procedures, departing aircraft should monitor/communicate on the appropriate CTAF from startup and during taxi so that they are aware of arrival aircraft landing at the airport. To mitigate a surface or midair collision, departing aircraft should communicate on the CTAF prior to entering the runway environment so not to create a collision hazard. This requires the departing aircraft to “see-and-avoid” any

aircraft that may be on short final prior to entering the runway for takeoff and communicate their intentions, their departure runway, initial departure altitude, and direction of flight, and monitor CTAF until they are in contact with ATC.

Note 1: When receiving an IFR clearance release to enter airspace from ATC, with or without a clearance void time, you should not takeoff at a non-towered airport until you are positive that there is no inbound aircraft/traffic pattern conflicts. If your takeoff is going to be delayed, contact and advise ATC.

Note 2: Caution should be taken when receiving IFR clearances on the ground from a Remote Transmitter Receiver (RTR) or a Remote Communications Outlet (RCO), as these can limit your situational awareness of other aircraft that may be entering the traffic area for landing while you are not monitoring the CTAF/UNICOM.

10.4.4 Immediate IFR Departure. Pilots departing IFR are encouraged not to accept immediate IFR departures just to meet clearance void times as this increases the risk of a collision hazard on the runway when they conduct an immediate departure and another aircraft could be on short final, entering the runway from another location, or may be crossing the runway in use. As stated above, an ATC IFR clearance and ATC stating released are not authorizations to takeoff. Per paragraph 10.4.3, communicate on CTAF, announce your intention to takeoff; state the runway in use, initial departure altitude, and direction of flight; and call for any aircraft in the pattern or inbound to the airport for landing to obtain a complete understanding of all air traffic to be avoided.

11 RECOMMENDED STANDARD TRAFFIC PATTERN. The following information is intended to supplement the AIM, Paragraph 4-3-3, Traffic Patterns, and the PHAK, Chapter 14. Further, during preflight planning, you should check the Chart Supplement information for the airport of destination and in addition to obtaining airport information, check for any airport remarks and/or special procedures. This information can alert you to takeoff, landing, or other procedures, and ensure you are familiar with all available information regarding that airport.

11.1 Traffic Pattern Design. Airport owners and operators, in coordination with the FAA, are responsible for establishing traffic patterns. The FAA encourages airport owners and operators to establish traffic patterns as recommended in this AC. Further, left traffic patterns should be established, except where obstacles, terrain, and noise-sensitive areas dictate otherwise (see Appendix [A](#)).

11.2 Determination of Traffic Pattern. Prior to entering the traffic pattern at an airport without an operating control tower, aircraft should avoid the flow of traffic until established on the entry leg. For example, the pilot can check wind and landing direction indicators while at an altitude above the traffic pattern, or by monitoring the communications of other traffic that communicate the runway in use, especially at airports with more than one runway. When the runway in use and proper traffic pattern direction have been determined, the pilot should then proceed to a point well clear of the pattern before descending to and entering at pattern altitude.

- 11.3 Traffic Pattern Entry.** Arriving aircraft should be at traffic pattern altitude and allow for sufficient time to view the entire traffic pattern before entering. Entries into traffic patterns while descending may create collision hazards and should be avoided. Entry to the downwind leg should be at a 45-degree angle abeam the midpoint of the runway to be used for landing. Aircraft should always enter the pattern at pattern altitude, especially when flying over midfield and entering the downwind directly. See Appendices [A](#), [B](#), Glider Operations, and [C](#), Parachute Operations, for additional traffic pattern entry details.
- 11.4 Descent and Base Turn.** The traffic pattern altitude should be maintained until the aircraft is at least abeam the approach end of the landing runway on the downwind leg. The base leg turn should commence when the aircraft is at a point approximately 45 degrees relative bearing from the approach end of the runway.
- 11.5 Runway Preference.** Landing and takeoff should be accomplished on the operating runway most nearly aligned into the wind. However, if a secondary runway is used (e.g., for length limitations), pilots using the secondary runway should avoid the flow of traffic to the runway most nearly aligned into the wind.
- 11.6 Takeoff and Go-Around.** Airplanes on takeoff, or executing a go-around, should continue straight ahead until beyond the departure end of the runway, and the pilot maintaining awareness of other traffic so as not to conflict with those established in the pattern.
- 11.7 Turning Crosswind.** Airplanes remaining in the traffic pattern should not commence a turn to the crosswind leg until beyond the departure end of the runway and within 300 feet below traffic pattern altitude. Pilots should make the turn to downwind leg at the traffic pattern altitude.
- Note:** Pilots should be aware that the crosswind leg may be longer or shorter due to weather conditions that are unusually hot or cold.
- 11.8 Takeoff and Departing the Airport Pattern (the Departure Leg).** When departing the traffic pattern, airplanes should continue straight out or exit with a 45-degree left turn (right turn for right traffic pattern) beyond the departure end of the runway after reaching pattern altitude. Pilots need to be aware of any traffic entering the traffic pattern prior to commencing a turn.
- 11.9 Airspeed Limitations.** Airplanes should be operated in accordance with their pilot's operating handbook (POH)/Aircraft Flight Manual (AFM) landing procedures.
- 11.10 Landing Right-of-Way.** Section 91.113 provides the right-of-way when landing. The section states in relevant part, "Vigilance shall be maintained by each person operating an aircraft so as to see and avoid other aircraft...When two or more aircraft are approaching an airport for the purpose of landing, the aircraft at the lower altitude has the right-of-way, but it shall not take advantage of this rule to cut in front of another which is on final approach to land or to overtake that aircraft."

12 OTHER NON-TOWERED AIRPORT AIRCRAFT TRAFFIC PATTERNS.

Non-towered airport operators routinely establish local procedures for the operation of rotorcraft, gliders, ultralight vehicles, lighter-than-air aircraft, and parachute operations. See Appendices [A](#) for traffic patterns; [B](#) for glider operations, rotorcraft, ultralight vehicles, and lighter-than-air aircraft; and [C](#) for parachute operations, which provides details and recommended standard traffic patterns for these operations.

12.1 Rotorcraft.

- 12.1.1** In the case of a helicopter approaching to land other than on the runway in use, the pilot should avoid the flow of fixed-wing aircraft and land on a marked helipad or suitable clear area. Pilots should be aware that at some airports, the only suitable landing area is the runway, and a standard traffic pattern can be utilized if it does not conflict with any other fixed-wing traffic present at the time of landing.
- 12.1.2** All pilots should be aware that rotorcraft may fly slower and approach at steeper angles than airplanes. Air taxi is the preferred method for helicopter ground movements, which enables the pilot to proceed at an optimum airspeed, minimize downwash effect, and conserve fuel. Flight over aircraft, vehicles, and personnel should be avoided.
- 12.1.3** In the case of a gyroplane approaching to land, the gyroplane pilot operating in the traffic pattern when landing on the runway may fly a pattern similar to the fixed-wing aircraft traffic pattern but at a lower altitude (500 feet above ground level (AGL)) and closer to the runway. This runway pattern may be on the opposite side of the runway from fixed-wing traffic only when airspeed requires it or for practice power-off landings and if local policy permits. Landings not on the runway should avoid the flow of fixed-wing traffic.
- 12.1.4** Helicopters operating in the traffic pattern when landing on the runway may fly a pattern similar to the fixed-wing aircraft traffic pattern but at a lower altitude (500 feet AGL) and closer to the runway. This runway pattern may be on the opposite side of the runway from fixed-wing traffic only when airspeed requires it or for practice power-off landings (autorotation) and if local policy permits. Landings not on the runway should avoid the flow of fixed-wing traffic.
- 12.1.5** Both classes of rotorcraft can be expected to practice power-off landings (autorotation), which will involve a very steep angle of approach and high rate of descent (1,500 to 2,000 feet/minute).

12.2 Gliders.

- 12.2.1** A glider, including the tow aircraft during towing operations, has the right-of-way over powered aircraft.
- 12.2.2** If both airplanes and gliders use the same runway, the glider traffic pattern will be inside the pattern of engine-driven aircraft. If a glider operating area is established to one side of a powered-aircraft runway, the glider pattern will normally be on the side of the airport closest to the glider operating area. This will allow gliders to fly the same direction

traffic pattern as powered aircraft in certain wind conditions and necessitate a separate, opposing direction traffic pattern in other wind conditions. (See examples in Appendix [B](#).)

- 12.2.3** Typically, glider traffic patterns have entry points (initial points) from 600 to 1,000 feet AGL.

12.3 Ultralight Vehicles.

- 12.3.1** In accordance with 14 CFR part [103](#), ultralight vehicles are required to yield the right-of-way to all aircraft.
- 12.3.2** Ultralight vehicles should fly the rectangular pattern as described in Appendix B. Pattern altitude should be 500 feet below and inside the standard pattern established for the airport. An ultralight pattern with its own dedicated landing area will typically have a lower traffic pattern parallel to the standard pattern, with turns in the opposite direction.
- 12.3.3** All pilots should be aware that ultralights will fly significantly slower than airplanes. Ultralights may also exhibit very steep takeoff and approach angles. Turns may be executed near the end of the runway in order to clear the area expediently.

12.4 Lighter-Than-Air Aircraft.

- 12.4.1** A balloon has the right-of-way over any other category of aircraft and does not follow a standard traffic pattern.
- 12.4.2** Due to limited maneuverability, airships do not normally fly a standard traffic pattern. However, if a standard traffic pattern is flown, it will be at an airspeed below most other aircraft.

12.5 Parachute Operations.

- 12.5.1** All activities are normally conducted under a NOTAM noting the location, altitudes, and time or duration of jump operations. The Chart Supplement lists airports where permanent Drop Zones (DZ) are located.
- 12.5.2** Jumpers normally exit the aircraft either above, or well upwind of, the airport and at altitudes well above traffic pattern altitude. Parachutes are normally deployed between 2,000 feet and 5,000 feet AGL and can be expected to be below 3,000 feet AGL within 1 mile of the airport within the probable chute operating zone, or within 2 miles in extreme zone (see Appendix [C](#)). Pilots of jump aircraft are required by 14 CFR part [105](#) to establish two-way radio communications with the ATC facility that has jurisdiction over the affected airspace prior to jump operations for the purpose of receiving information in the aircraft about known air traffic in the vicinity. In addition, when jump aircraft are operating at or in the vicinity of an airport, pilots are also encouraged to provide advisory information on the CTAF. For example, “Chambersburg traffic, jumpers away over Chambersburg.”

- 12.5.3** When a DZ has been established at an airport, parachutists are expected to land within the DZ. At airports that have not established DZs, parachutists should avoid landing on runways, taxiways, aprons, and their associated safety areas. Pilots and parachutists should both be aware of the limited flight performance of parachutes and take steps to avoid any potential conflicts between aircraft and parachute operations. Appendix C provides dimensions of a parachute operation's DZ, and an example of an airport's Chart Supplement information for parachute operations.
- 13 AC FEEDBACK FORM.** For your convenience, the AC Feedback Form is the last page of this AC. Note any deficiencies found, clarifications needed, or suggested improvements regarding the contents of this AC on the Feedback Form.



Wesley L. Mooty
Acting Deputy Executive Director, Flight Standards Service

APPENDIX A. TRAFFIC PATTERNS

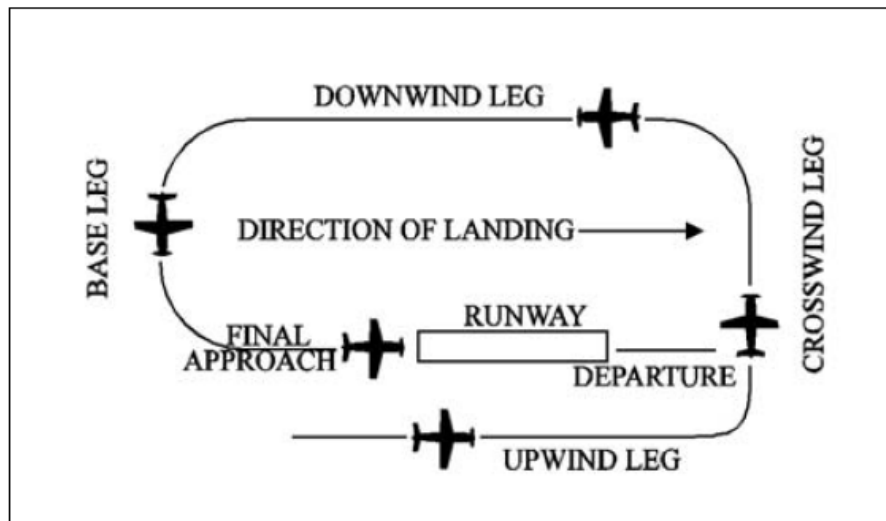
Components of a Traffic Pattern (Refer to [AIM](#) Chapter 4)

Note: This diagram is intended only to illustrate terminology used in identifying various components of a traffic pattern. It should not be used as a reference or guide on how to enter a traffic pattern.

1. **Upwind leg.** A flight path parallel to the landing runway in the direction of landing. *Note: The upwind leg is separate and distinct from the departure leg and often used to reference the flight path flown after takeoff (or a touch and go).*
2. **Crosswind leg.** A flight path at right angles to the landing runway off its end.
3. **Downwind leg.** A flight path parallel to the landing runway in the opposite direction of landing.
4. **Base leg.** A flight path at right angles to the landing runway off its approach end. The base leg extends from the downwind leg to the intersection of the extended runway centerline.
5. **Final approach.** A flight path in the direction of landing along the extended runway centerline from the base leg to the runway.
6. **Departure—Departing the airport's traffic area.** The flight path which begins after takeoff and continues straight ahead along the extended runway centerline. *Note: The departure climb continues until reaching a point at least 1/2 mile beyond the departure end of the runway and within 300 feet of the traffic pattern altitude, and the aircraft continues on its direction of flight away from the airport.*

Note: Aircraft should always enter the pattern at pattern altitude published for the respective airport. A midfield crossing alternate pattern entry should not be used when the pattern is congested.

Note: Descending into the traffic pattern can be dangerous, as one aircraft could descend on top of another aircraft that is already in the pattern. All similar types of aircraft, including those entering on the 45-degree angle to downwind, should be at the same pattern altitude so that it is easier to visually acquire any traffic in the pattern.

Single Runway (Diagram from the AIM, Paragraph 4-3-3)

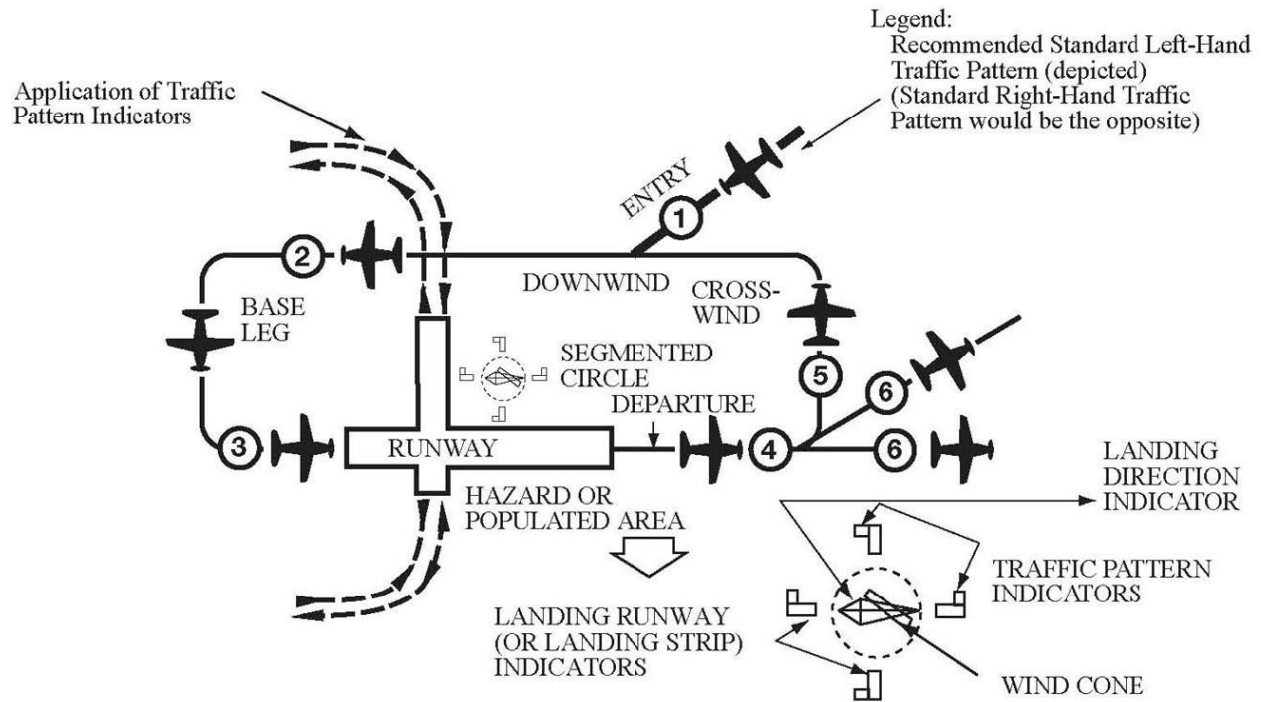

Traffic pattern operations—single runway (PHAK)

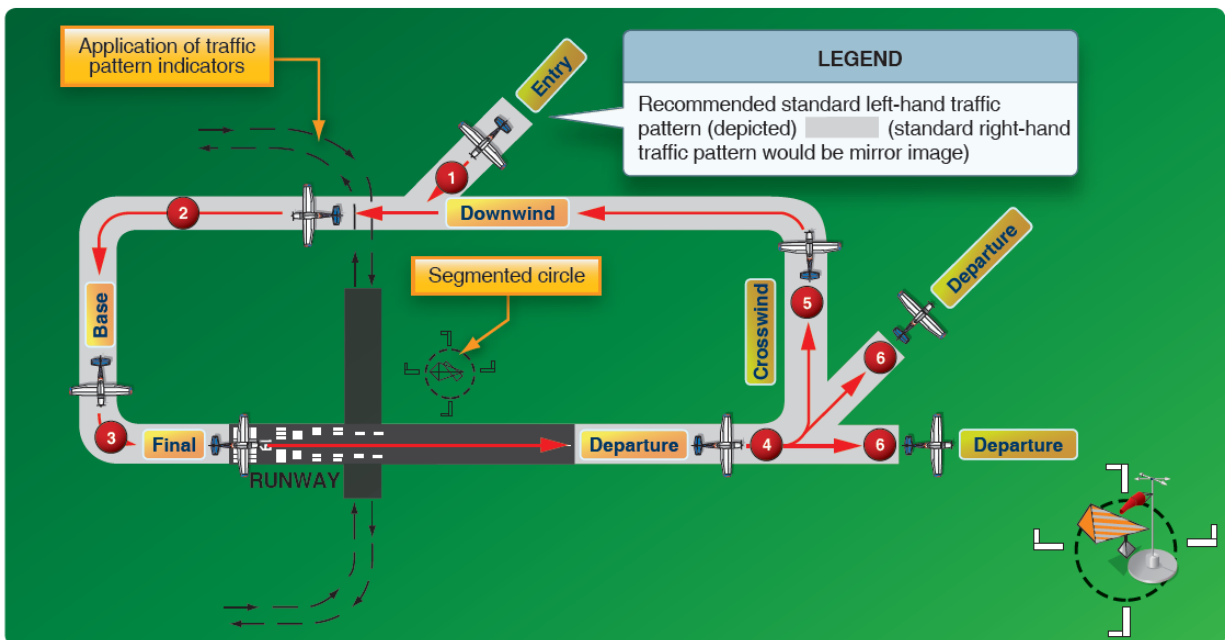

EXAMPLE-

Key to traffic pattern operations:

1. Enter pattern in level flight, abeam the midpoint of the runway, at pattern altitude.
2. Maintain pattern altitude until abeam approach end of the landing runway on downwind leg, begin descent and turn base at approximately 45 degrees from the intended landing point.
3. Complete turn to final at least 1/4 mile from the runway.
4. Continue straight ahead until beyond departure end of runway.
5. If remaining in the traffic pattern, commence turn to crosswind leg beyond the departure end of the runway within 300 feet of pattern altitude.
6. If departing the traffic pattern, continue straight out, or exit with a 45-degree turn (to the left when in a left-hand traffic pattern; to the right when in a right-hand traffic pattern) beyond the departure end of the runway, after reaching pattern altitude.

Parallel Runways (Diagram from the AIM, Paragraph 4-3-3)

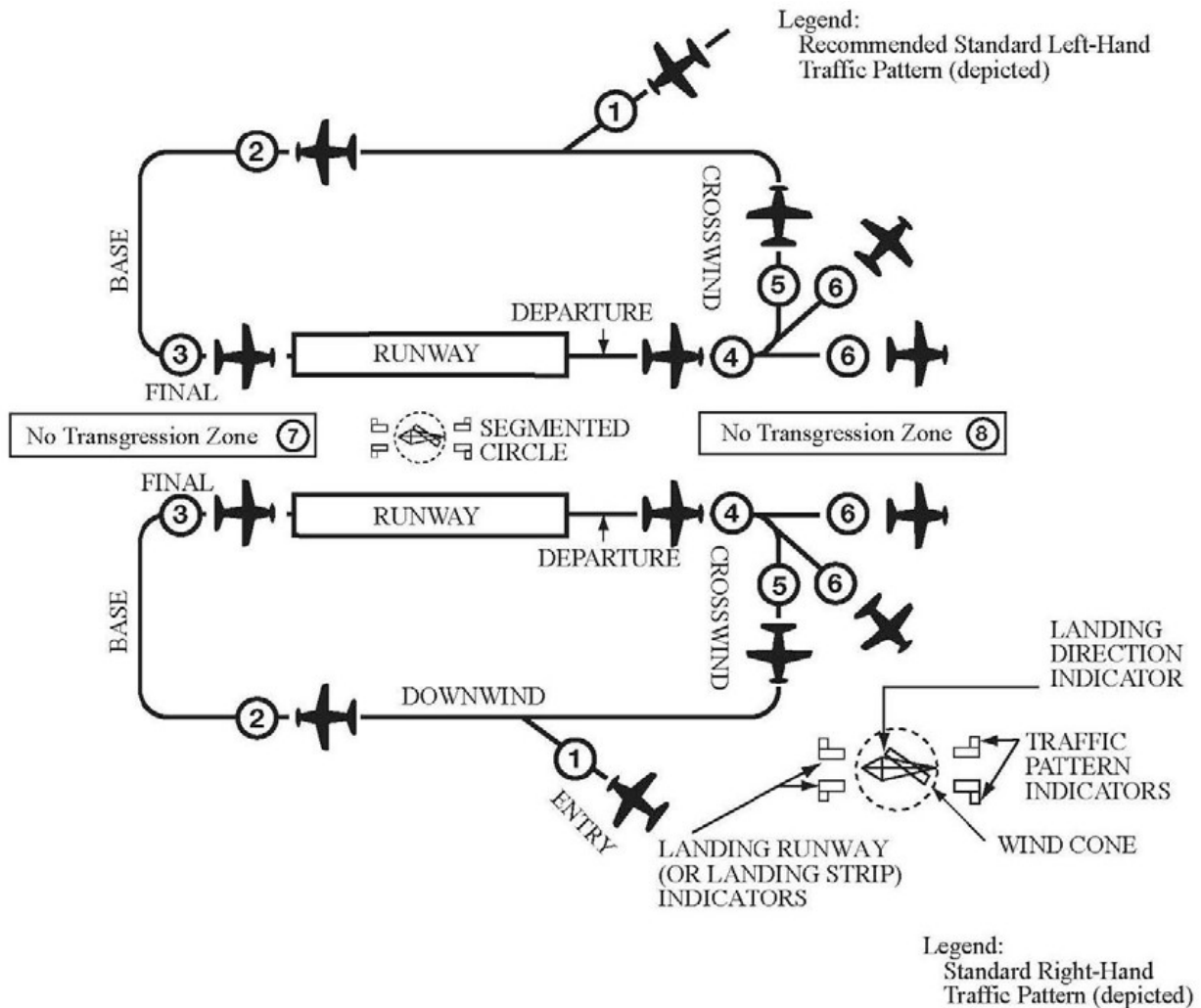

Traffic Pattern Operation—Parallel Runways (PHAK)

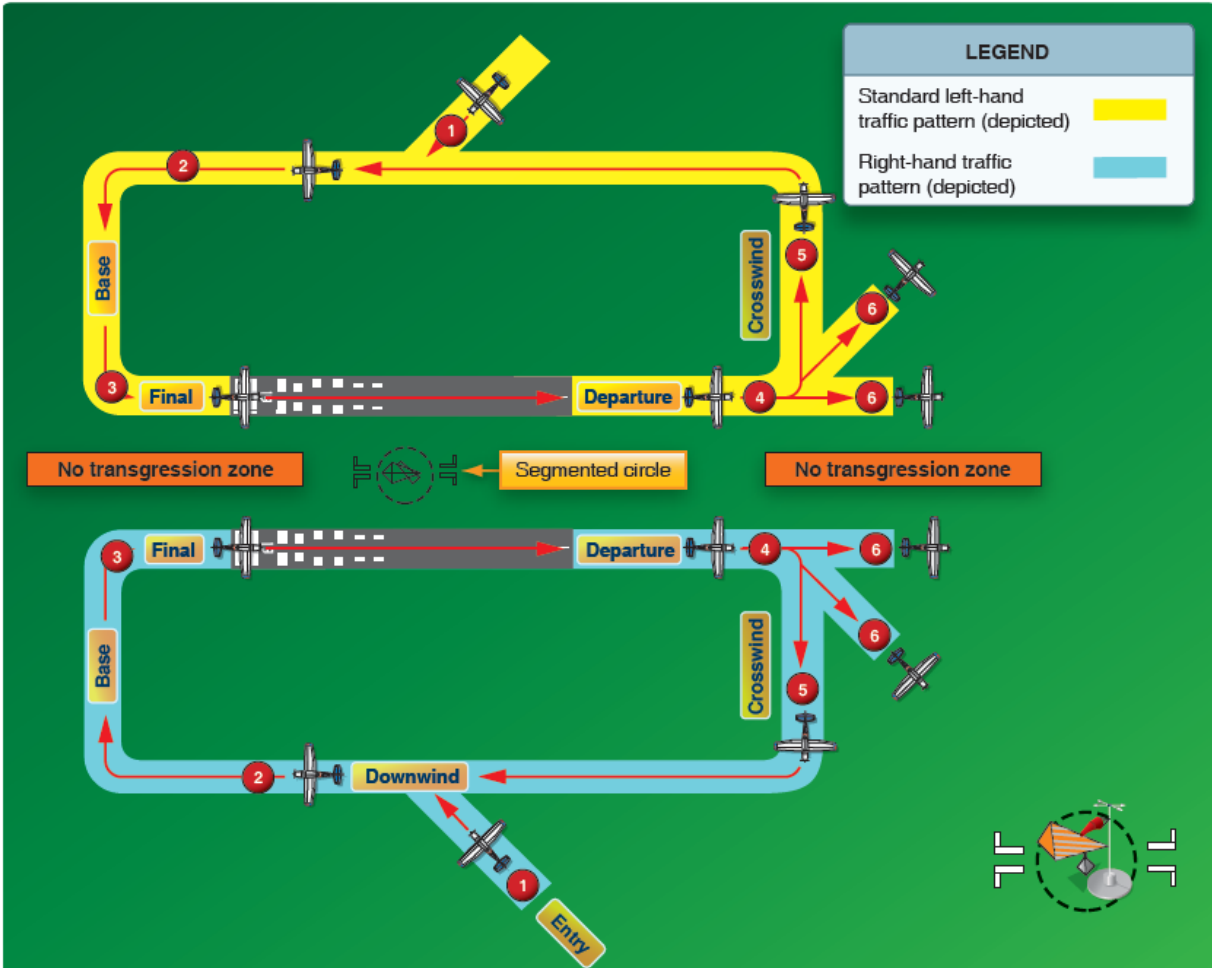

EXAMPLE—

Key to traffic pattern operations:

1. Enter pattern in level flight, abeam the midpoint of the runway, at pattern altitude.
2. Maintain pattern altitude until abeam approach end of the landing runway on downwind leg, begin descent and turn base at approximately 45 degrees from the intended landing point.
3. Complete turn to final at least ¼ mile from the runway.
4. Continue straight ahead until beyond departure end of runway.
5. If remaining in the traffic pattern, commence turn to crosswind leg beyond the departure end of the runway within 300 feet of pattern altitude.
6. If departing the traffic pattern, continue straight out, or exit with a 45-degree turn (to the left when in a left-hand traffic pattern; to the right when in a right-hand traffic pattern) beyond the departure end of the runway, after reaching pattern altitude.
7. Do not overshoot final or continue on a track which will penetrate the final approach of the parallel runway.
8. Do not continue on a track which will penetrate the departure path of the parallel runway.

Alternate method to the 45 degree to the downwind leg. Preferred entry from upwind leg side of airport (A). Alternate midfield entry from upwind leg side of airport (B). Refer to the [Airplane Flying Handbook](#), Chapter 7.

Note: Aircraft should always enter the pattern at pattern altitude, especially when flying over midfield and entering the downwind directly.

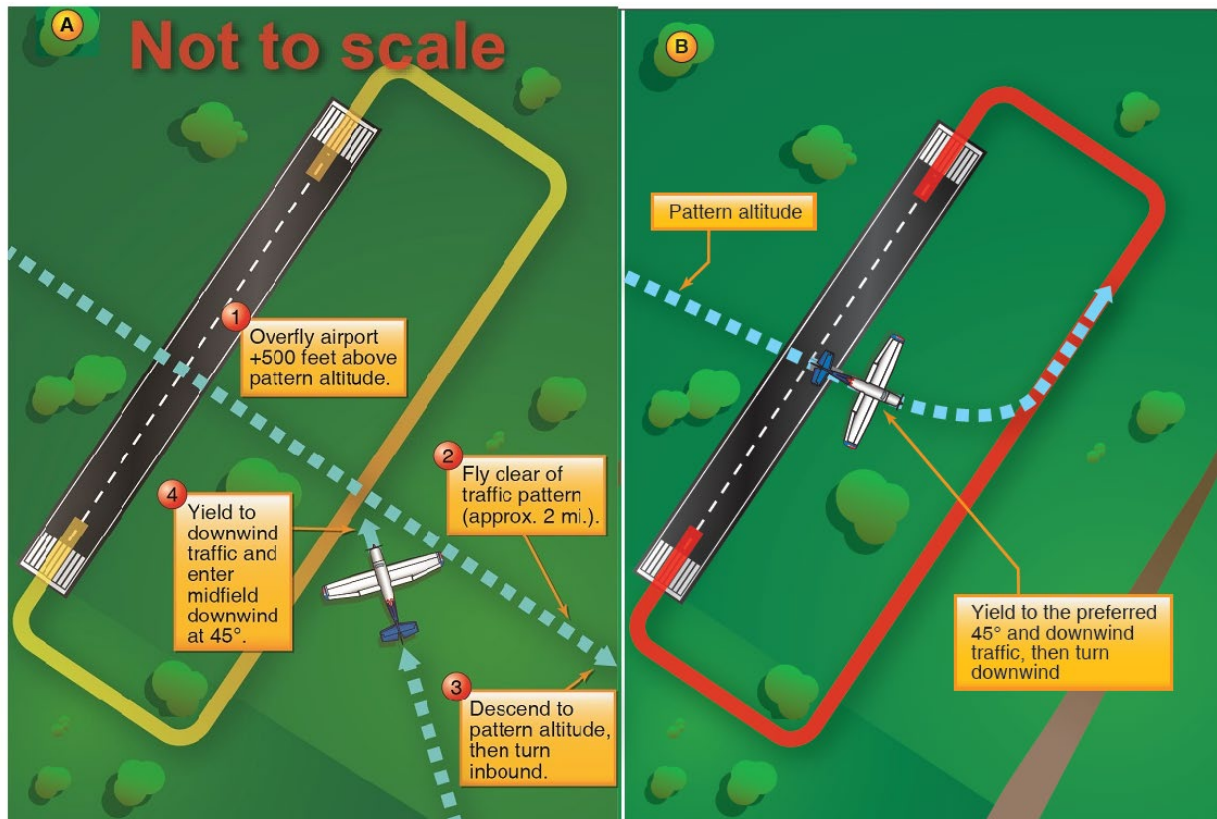

Traffic Pattern Altitudes. Refer to the Airplane Flying Handbook, Chapter 7, and the AIM, paragraph 4-3-3. Enter pattern in level flight, abeam the midpoint of the runway, at pattern altitude. The traffic pattern altitude is usually, unless otherwise established for a respective airport, 1,000 feet above the elevation of the airport surface. The use of a common altitude at a given airport is the key factor in minimizing the risk of collisions at airports without operating control towers. A pilot may vary the size of the traffic pattern depending on the aircraft's performance characteristics.

Unless a specific traffic pattern altitude is published in the Chart Supplement entry for the airport, it is recommended that:

1. Propeller-Driven Aircraft. Propeller-driven aircraft enter the traffic pattern at 1,000 feet above the airport surface (above ground level (AGL)).
2. Turbine-Powered Airplanes. Large and turbine-powered airplanes enter the traffic pattern at an altitude of not less than 1,500 feet above the airport elevation, or 500 feet above the established pattern altitude.

3. Ultralight Aircraft. An ultralight aircraft should operate no higher than 500 feet below the powered aircraft pattern altitude. A pilot may vary the size of the traffic pattern depending on the aircraft's performance characteristics.
4. Helicopter Operations. The AIM, Chapter 4, Section 3, Airport Operations, states in part, "Pilots approaching to land in a helicopter must avoid the flow of fixed-wing traffic." Though neither the AIM nor 14 CFR do provide traffic pattern operations for helicopters, the FAA highly recommends that helicopter pilots operating in the traffic pattern may fly a pattern similar to the airplane pattern at a lower altitude (500 AGL) and closer to the airport. This pattern may be on the opposite side of the runway with turns in the opposite direction if local policy permits.

APPENDIX B. GLIDER OPERATIONS

Sample Glider Operations and Ultralight Aircraft Pattern

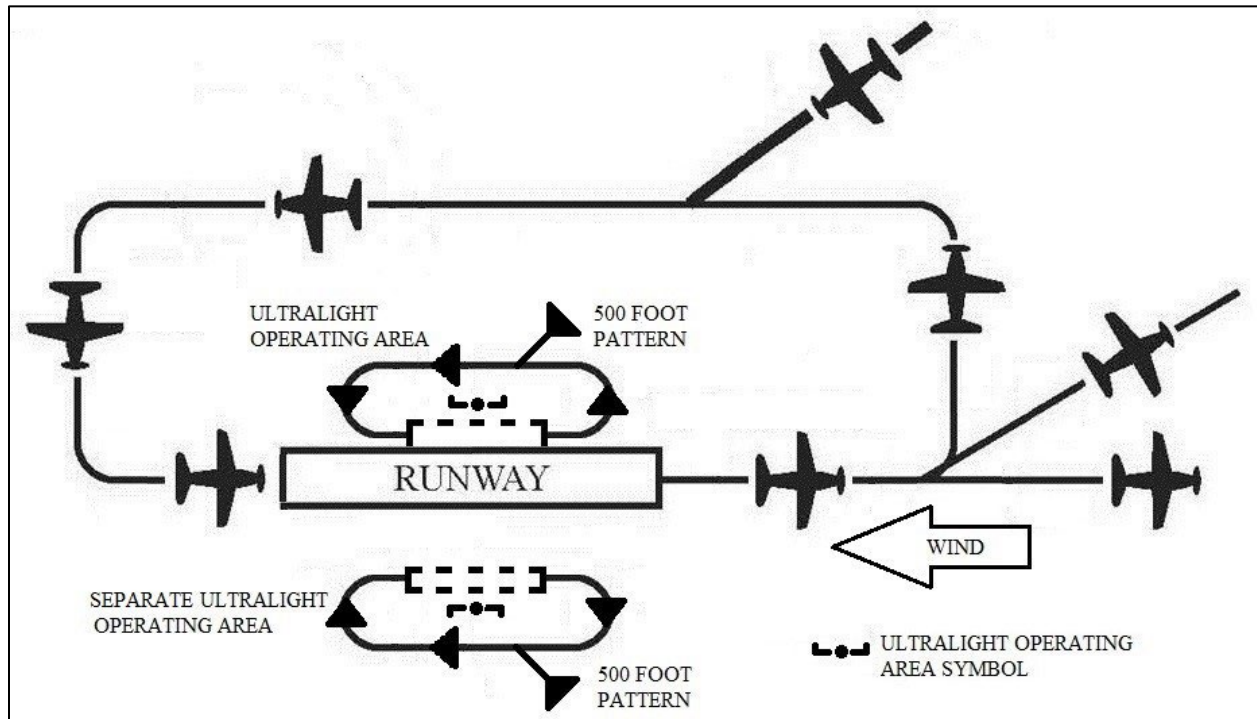

Per AC [103-6](#), Ultralight Vehicle Operations—Airports, Air Traffic Control, and Weather, in all radio communications, ultralight operators should state the word “ultralight” followed by the call letters. Finally, once you have completed your landing or have exited the area, it is good practice to let other aviators know that you are no longer airborne in the vicinity of the airport. For example, state, “Leesburg, Ultralight 12593U is clear of the Runway” or “Leesburg, Ultralight 12593U is 2 Miles South, Leaving the Area.”

Sample Glider Aircraft Pattern

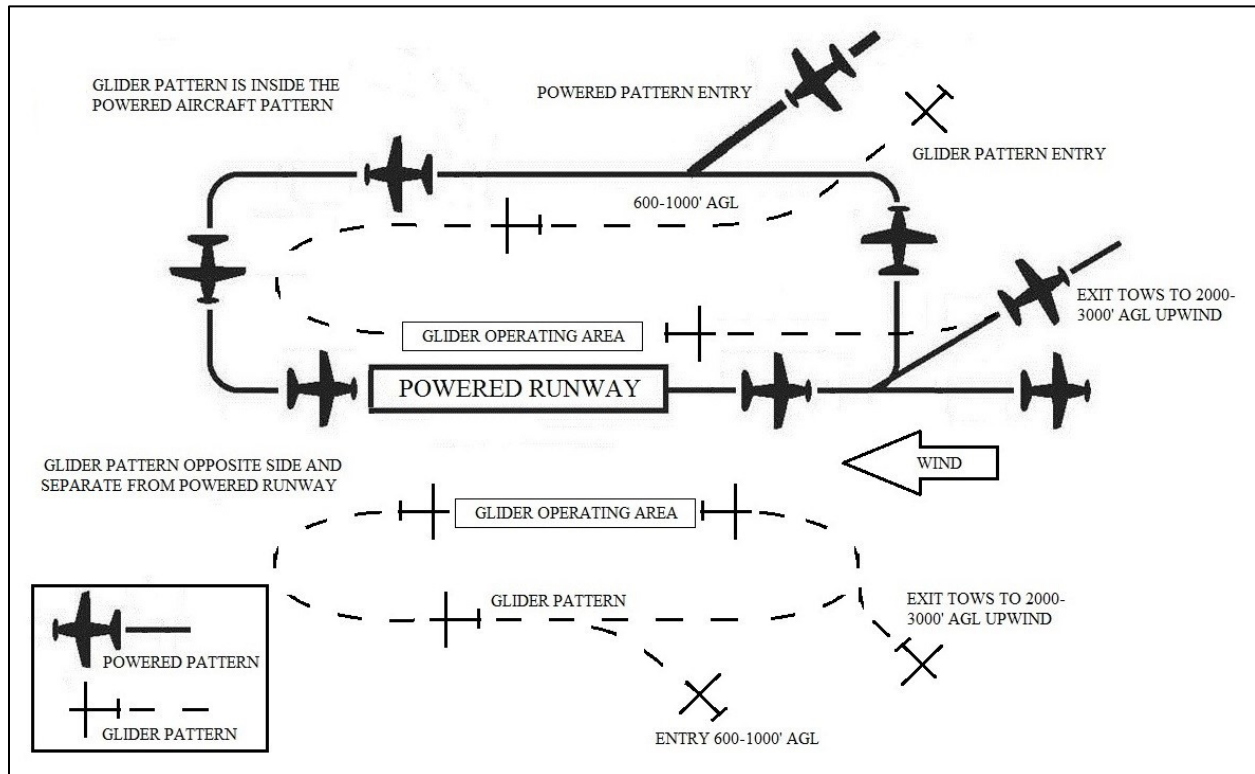

Check the respective airport's Chart Supplement for specific information regarding glider operations. The example above is from Shirley, New York's Brookhaven Airport (KHWV).

Glider ops dalgt (daylight) hrs. Pilots be aware when conducting practice ILS apchs (approaches), extensive lgt acft (light aircraft) training on and invof arpt (in the vicinity airports) all hrs. **Gliders use rgt tfc pat (right traffic pattern) for Rwy 24 and Rwy 33, gliders use left tfc pat (left traffic pattern) for Rwy 06 and Rwy 15.** No TGL wkend, hol (weekend, holiday,) and non dalgt (daylight) hrs.

APPENDIX C. PARACHUTE OPERATIONS

Per United States Parachute Association Drop Zone (DZ) dimensions

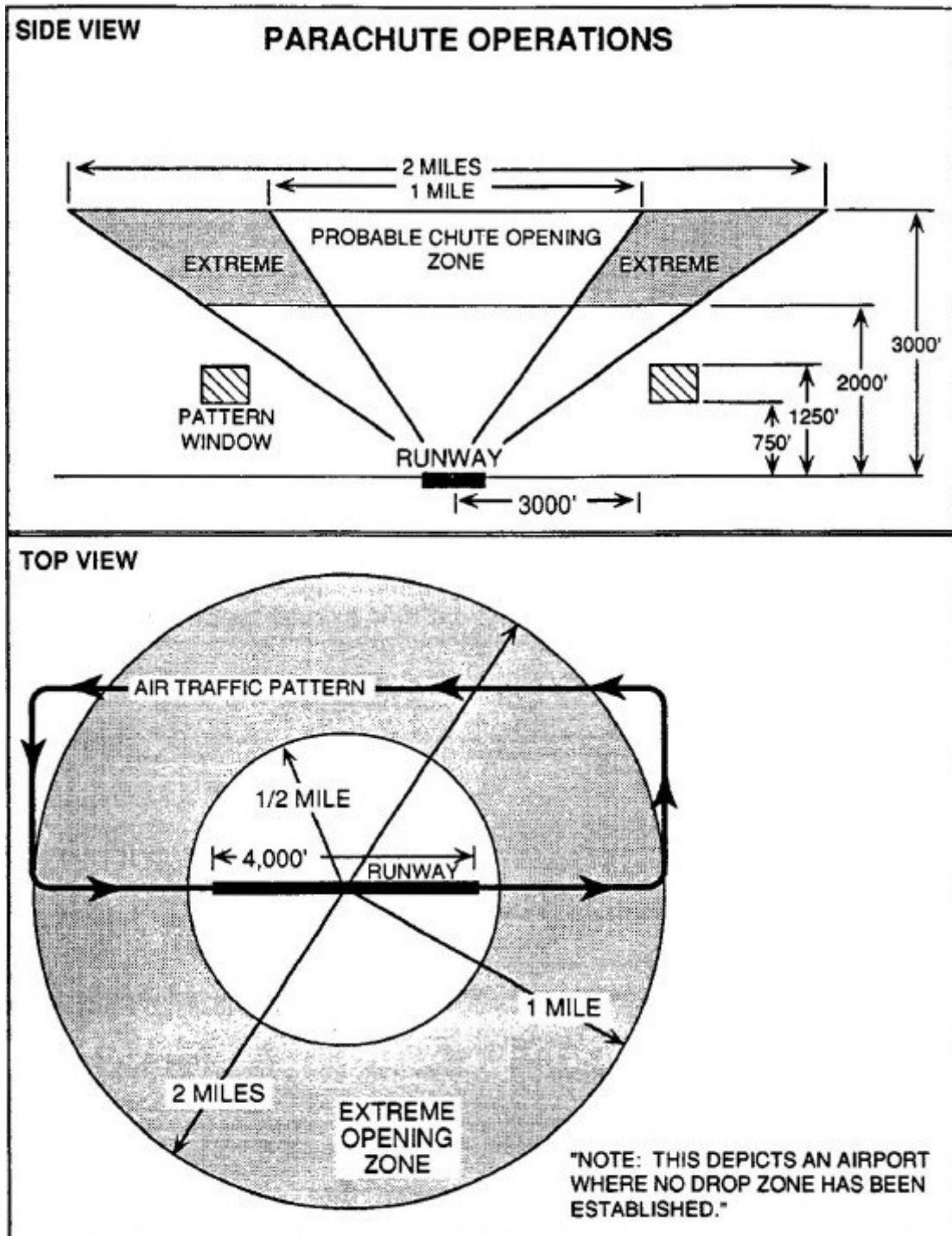

Example of non-towered airport Chart Supplement information: Parachute Jumping. Extensive parachute jumping activity in vicinity of arpt. (Per Chart Supplement legend, "in vicinity of", and "arpt" means "airport.")

Advisory Circular Feedback Form

If you find an error in this AC, have recommendations for improving it, or have suggestions for new items/subjects to be added, you may let us know by contacting the General Aviation and Commercial Division at 9-AFS-800-Correspondence@faa.gov or the Flight Standards Directives Management Officer at 9-AWA-AFB-120-Directives@faa.gov.

Subject: AC 90-66C, Non-Towered Airport Flight Operations

Date: _____

Please check all appropriate line items:

An error (procedural or typographical) has been noted in paragraph _____
on page _____.

Recommend paragraph _____ on page _____ be changed as follows:

In a future change to this AC, please cover the following subject:
(Briefly describe what you want added.)

Other comments:

I would like to discuss the above. Please contact me.

Submitted by: _____

Date: _____